

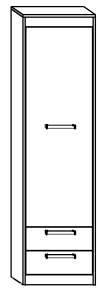

# MXS-01

## BIELIŹNIARKA 1D2S

→ 52+193\36



x 8 	x 22 	x 2 	x 24 	x 8 	x 4 		
x 3 	x 3 	x 8 	x 4 	x 4 	x 38 (3,5x16) 	x 8 (3,5x30) 	x 80 
x 1 	x 3 		x 2 kpl. (300 mm) 		  40 min		

**1** - FAZY MONTAŻU

**A** - OZNACZENIE ELEMENTÓW

**a** - OZNACZENIE AKCESORIÓW

**1**

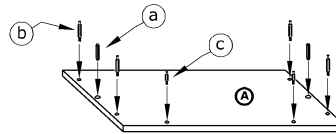
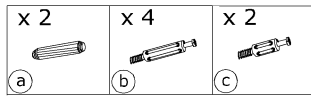

**2**

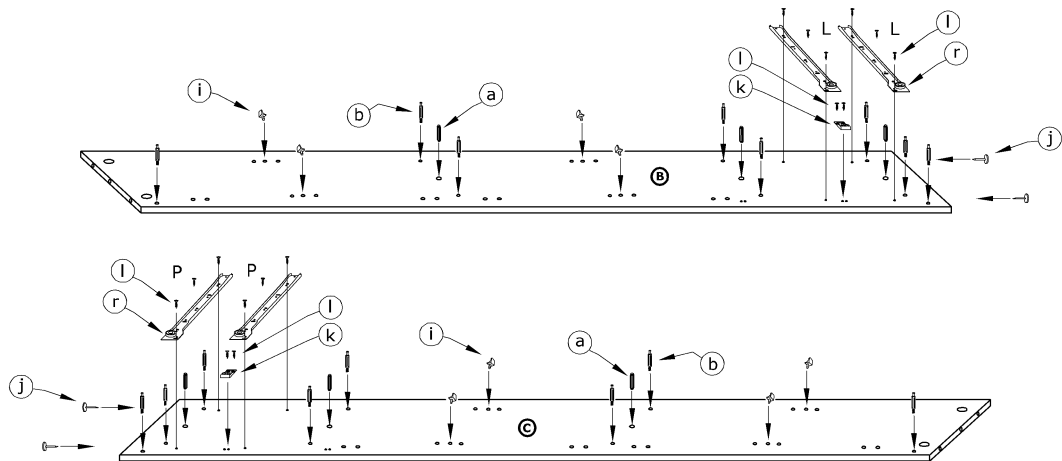
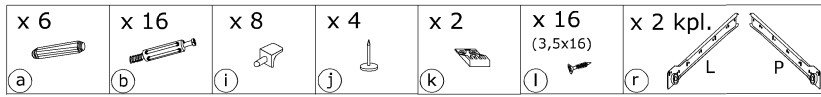

**3**

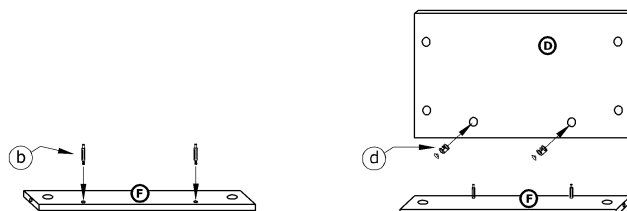
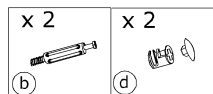

4

x 16  
d

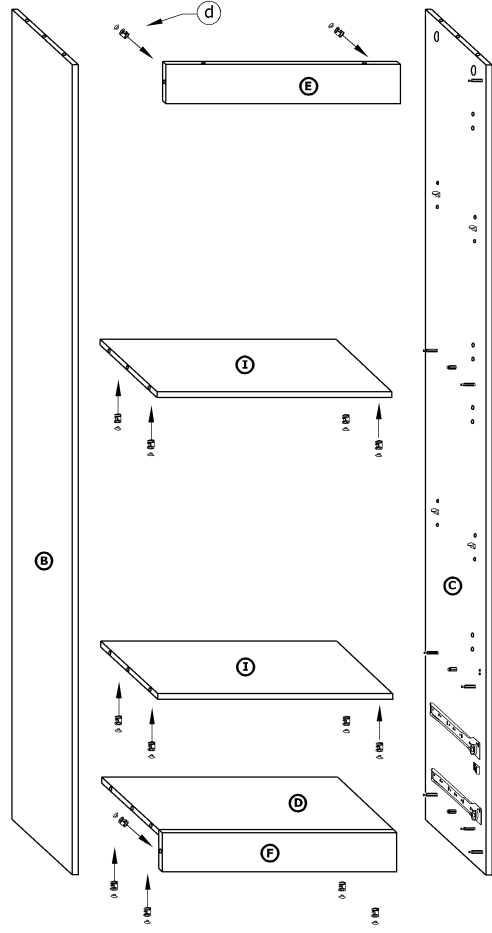

5

x 6  
d  
x 50  
n

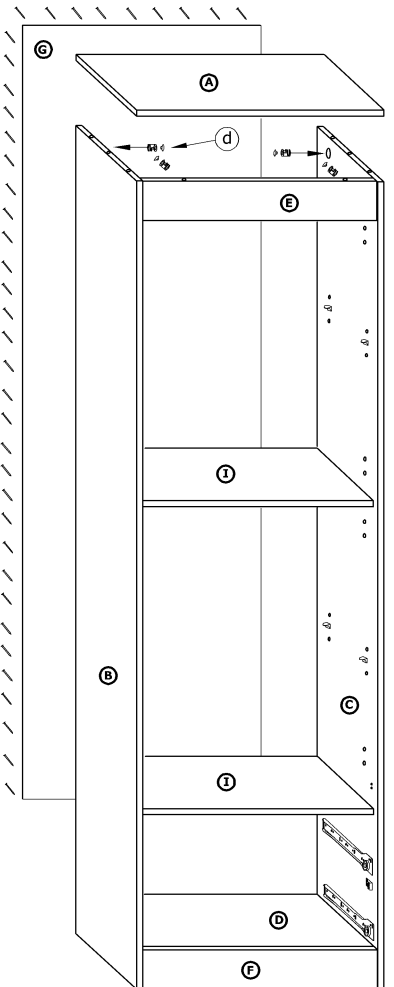

6

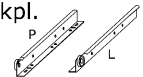
x 8 e	x 4 f	x 12 (3,5x16) l	x 4 (3,5x30) m
x 30 n	x 2 kpl. r		

X 2

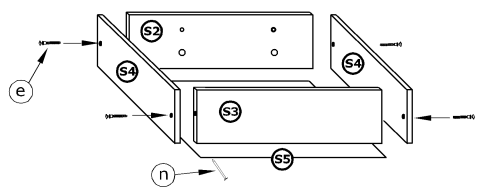

X 2

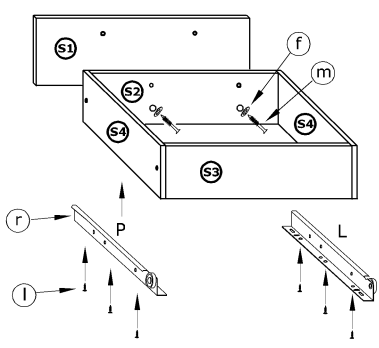

7

x 3 g
x 3 h
x 2 k
x 10 (3,5x16) l
x 4 (3,5x30) m
x 3 p

